

NPN SILICON PLANAR EPITAXIAL TRANSISTORS

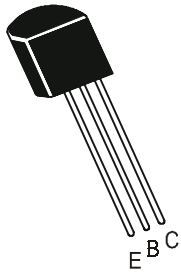

MPS2222
MPS2222A

TO-92
Plastic Package

General Purpose Transistors

ABSOLUTE MAXIMUM RATINGS(Ta=25°C unless specified otherwise)

DESCRIPTION	SYMBOL	MPS2222	MPS2222A	UNITS
Collector Emitter Voltage	V_{CEO}	30	40	V
Collector Base Voltage	V_{CBO}	60	75	V
Emitter Base Voltage	V_{EBO}	5	6	V
Collector Current Continuous	I_C	600		mA
Power Dissipation@ Ta=25°C	P_D	625		mW
Derate Above 25°C		5.0		mW/°C
Power Dissipation@ Tc=25°C	P_D	1.5		W
Derate Above 25°C		12		mW/°C
Operating And Storage Junction Temperature Range	T_j, T_{stg}	-55 to +150		°C
THERMAL RESISTANCE				
Junction to ambient	$R_{th(j-a)}$	200		°C/W
Junction to case	$R_{th(j-c)}$	83.3		°C/W

NPN SILICON PLANAR EPITAXIAL TRANSISTORS

MPS2222
MPS2222A

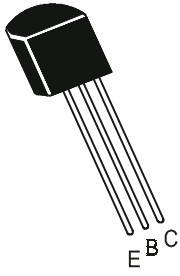

TO-92
Plastic Package

ELECTRICAL CHARACTERISTICS (Ta=25°C Unless Specified Otherwise)

DESCRIPTION	SYMBOL	TEST CONDITION	MPS2222	MPS2222A	UNITS
Collector Emitter Voltage	BV_{CEO}	$I_C=10mA, I_B=0$	>30	>40	V
Collector Base Voltage	BV_{CBO}	$I_C=10\mu A, I_E=0$	>60	>75	V
Emitter Base Voltage	BV_{EBO}	$I_E=10\mu A, I_C=0$	>5	>6	V
Collector Cut off Current	I_{CEX}	$V_{CE}=60V, V_{BE}=3.0V$		<10	nA
Collector Cut off Current	I_{CBO}		<0.01		μA
	I_{CBO}	$V_{CB}=50V, I_E=0$		<0.01	μA
	I_{CBO}	$V_{CB}=60V, I_E=0$	<10		μA
	I_{CBO}	$V_{CB}=50V, I_E=0$ Ta= 125°C		<10	μA
	I_{CBO}	$V_{CB}=60V, I_E=0$ Ta= 125°C			
Emitter Cut off Current	I_{EBO}	$V_{BE}=3V, I_C=0$		<10	nA
Base Cut off Current	I_{BL}	$V_{CE}=60V, V_{BE}=3.0V$		<20	nA
DC Current Gain					μA
	h_{FE}	$V_{CE}=10V, I_C=0.1mA$	>35	>35	
		$V_{CE}=10V, I_C=1mA$	>50	>50	
		$V_{CE}=10V, I_C=10mA$	>75	>75	
		$V_{CE}=10V, I_C=10mA$ TA = -55 °C		>35	
		$V_{CE}=10V^*, I_C=150mA$	100-300	100-300	
		$V_{CE}=1V^*, I_C=150mA$	>50	>50	
		$V_{CE}=10V^*, I_C=500mA$	>30	>40	
	$V_{BE(sat)}^*$	$I_C=150mA, I_B=15mA$	<1.3	0.6-1.2	V
	$V_{BE(sat)}^*$	$I_C=500mA, I_B=50mA$	<2.6	<2.0	V
	$V_{CE(sat)}^*$	$I_C=150mA, I_B=15mA$	<0.4	<0.3	V
		$I_C=500mA, I_B=50mA$	<1.6	<1.0	V

NPN SILICON PLANAR EPITAXIAL TRANSISTORS

MPS2222
MPS2222A

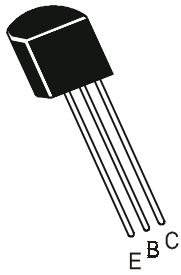

TO-92
Plastic Package

ELECTRICAL CHARACTERISTICS (Ta=25°C Unless Specified Otherwise)

DESCRIPTION	SYMBOL	TEST CONDITION	MPS2222	MPS2222A	UNITS
DYNAMIC CHARACTERISTICS					
Transition Frequency	f_T	$I_C=20\text{mA}, V_{CE}=20\text{V}$ $f=100\text{MHz}$	>250	>300	MHz
Output Capacitance	C_{ob}	$I_E=0, V_{CB}=10\text{V}$ $f=1\text{MHz}$		<8	pF
Input Capacitance	C_{ib}	$I_C=0, V_{EB}=0.5\text{V}$ $f=1\text{MHz}$	<30	<25	pF
Input Impedance	h_{ie}	$I_C=1\text{mA}, V_{CE}=10\text{V}$ $f=1\text{KHz}$		2.0-8.0	KW
		$I_C=10\text{mA}, V_{CE}=10\text{V}$ $f=1\text{KHz}$		0.25-1.25	KW
Reverse Voltage Transfer Ratio	h_{re}	$I_C=1\text{mA}, V_{CE}=10\text{V}$ $f=1\text{KHz}$		<8	$\times 10^{-4}$
		$I_C=10\text{mA}, V_{CE}=10\text{V}$ $f=1\text{KHz}$		<4	$\times 10^{-4}$
Output Admittance	h_{oe}	$I_C=1\text{mA}, V_{CE}=10\text{V}$ $f=1\text{KHz}$		5-35	μMHO
		$I_C=10\text{mA}, V_{CE}=10\text{V}$ $f=1\text{KHz}$		25-200	μMHO
Noise Figure	NF	$V_{CE}=10\text{V}, I_C=100\mu\text{A}$ $R_S=1\text{KOHMS}, f=1\text{KHz}$		<4	dB
Collector Base Time Constant	$r_b' C_c$	$V_{CE}=20\text{V}, I_C=20\text{mA}$ $f=31.8\text{MHz}$		<150	ps
Small Signal Current Gain	$ h_{fe} $	$V_{CE}=10\text{V}, I_C=1\text{mA}$ $f=1\text{KHz}$		50-300	
		$V_{CE}=10\text{V}, I_C=10\text{mA}$ $f=1\text{KHz}$		75-375	

SWITCHING CHARACTERISTICS

	SYMBOL	TEST CONDITION	MPS2222	MPS2222A	UNITS
Delay Time/Rise Time	t_d	$V_{CC}=30\text{V}, V_{EB}=0.5\text{V}$		<10	ns
	t_r	$I_C=150\text{mA}, I_{B1}=15\text{mA}$		<25	ns
Storage Time/Fall Time	t_s	$I_C=150\text{mA}, I_{B1}=I_{B2}=15\text{mA}$		<225	ns
	t_f	$V_{CC}=30\text{V}$		<60	ns

*Pulse Condition: = Width \leq 300us, Duty Cycle \leq 2%.

TO-92 Plastic Package

TO-92 Transistors on Tape and Ammo Pack

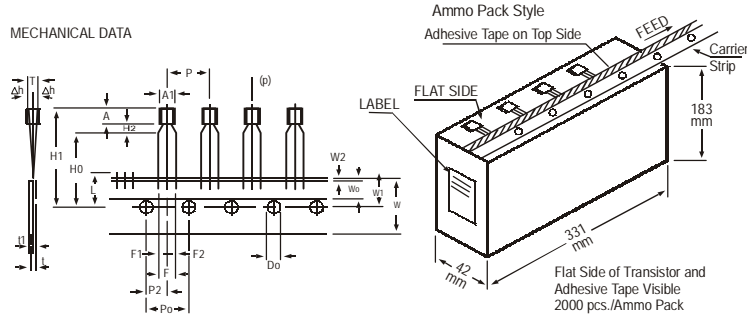
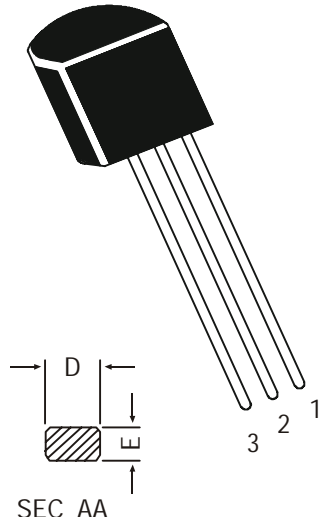
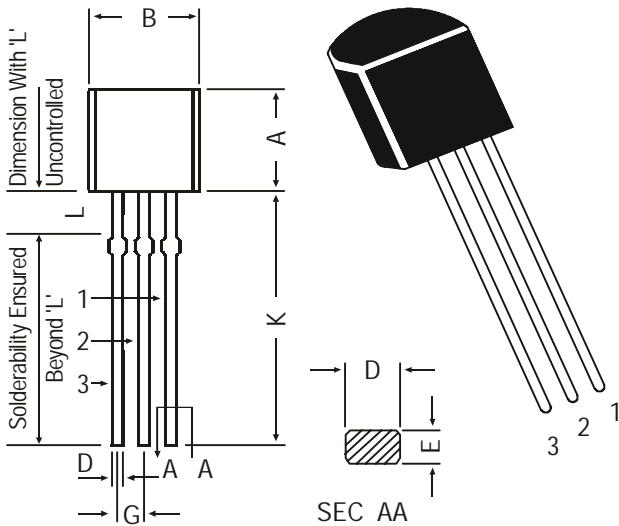

All dimensions in mm unless specified otherwise

ITEM	SYMBOL	SPECIFICATION				REMARKS
		MIN.	NOM.	MAX.	TOL.	
BODY WIDTH	A1	4.0		4.8		
BODY HEIGHT	A	4.8		5.2		
BODY THICKNESS	T	3.9		4.2		
PITCH OF COMPONENT	P		12.7		±1	
FEED HOLE PITCH	Po		12.7		±0.3	CUMULATIVE PITCH ERROR 1.0 mm/20 PITCH
FEED HOLE CENTRE TO COMPONENT CENTRE	P2		6.35		±0.4	TO BE MEASURED AT BOTTOM OF CLINCH
DISTANCE BETWEEN OUTER LEADS	F		5.08		+0.6 -0.2	
COMPONENT ALIGNMENT	Δh		0	1		AT TOP OF BODY
TAPE WIDTH	W		18		±0.5	
HOLD-DOWN TAPE WIDTH	Wo		6		±0.2	
HOLE POSITION	W1		9		+0.7 -0.5	
HOLD-DOWN TAPE POSITION	W2		0.5		±0.2	
LEAD WIRE CLINCH HEIGHT	Ho		16		±0.5	
COMPONENT HEIGHT	H1			23.25		
LENGTH OF SNIPPED LEADS	L			11.0		
FEED HOLE DIAMETER	Do		4		±0.2	
TOTAL TAPE THICKNESS	t			1.2		1) 0.3 - 0.6
LEAD - TO - LEAD DISTANCE F1,	F2		2.54		+0.4 -0.1	
CLINCH HEIGHT	H2			3		
PULL - OUT FORCE	(P)		6N			

NOTES

1. MAXIMUM ALIGNMENT DEVIATION BETWEEN LEADS NOT TO BE GREATER THAN 0.2 mm.
2. MAXIMUM NON-CUMULATIVE VARIATION BETWEEN TAPE FEED HOLES SHALL NOT EXCEED 1 mm IN 20 PITCHES.
3. HOLDDOWN TAPE NOT TO EXCEED BEYOND THE EDGE(S) OF CARRIER TAPE AND THERE SHALL BE NO EXPOSURE OF ADHESIVE.
4. NO MORE THAN 3 CONSECUTIVE MISSING COMPONENTS ARE PERMITTED.
5. A TAPE TRAILER, HAVING AT LEAST THREE FEED HOLES ARE REQUIRED AFTER THE LAST COMPONENT.
6. SPLICES SHALL NOT INTERFERE WITH THE SPROCKET FEED HOLES.

DIM	MIN.	MAX.
A	4.32	5.33
B	4.45	5.20
C	3.18	4.19
D	0.41	0.55
E	0.35	0.50
F	5 DEG	
G	1.14	1.40
H	1.14	1.53
K	12.70	—
L	1.982	2.082

All dimensions in mm.

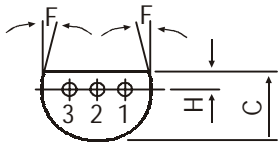

- PIN CONFIGURATION**
1. COLLECTOR
 2. BASE
 3. EMITTER

Packing Detail

PACKAGE	STANDARD PACK		INNER CARTON BOX		OUTER CARTON BOX		
	Details	Net Weight/Qty	Size	Qty	Size	Qty	Gr Wt
TO-92 Bulk	1K/polybag	200 gm/1K pcs	3" x 7.5" x 7.5"	5K	17" x 15" x 13.5"	80K	23 kgs
TO-92 T&A	2K/ammo box	645 gm/2K pcs	12.5" x 8" x 1.8"	2K	17" x 15" x 13.5"	32K	12.5 kgs

Disclaimer

The product information and the selection guides facilitate selection of the CDIL's Discrete Semiconductor Device(s) best suited for application in your product(s) as per your requirement. It is recommended that you completely review our Data Sheet(s) so as to confirm that the Device(s) meet functionality parameters for your application. The information furnished in the Data Sheet and on the CDIL Web Site/CD are believed to be accurate and reliable. CDIL however, does not assume responsibility for inaccuracies or incomplete information. Furthermore, CDIL does not assume liability whatsoever, arising out of the application or use of any CDIL product; neither does it convey any license under its patent rights nor rights of others. These products are not designed for use in life saving/support appliances or systems. CDIL customers selling these products (either as individual Discrete Semiconductor Devices or incorporated in their end products), in any life saving/support appliances or systems or applications do so at their own risk and CDIL will not be responsible for any damages resulting from such sale(s).

CDIL strives for continuous improvement and reserves the right to change the specifications of its products without prior notice.



CDIL is a registered Trademark of

Continental Device India Limited

C-120 Naraina Industrial Area, New Delhi 110 028, India.

Telephone + 91-11-2579 6150, 5141 1112 Fax + 91-11-2579 5290, 5141 1119

email@cdil.com www.cdilsemi.com